

Data Sheet



Article number: 025819360110

Description: Norma Connect pipe coupling
PLAST GRIP PGL W5 Ø=110,0 EPDM, 16 bar

Measures

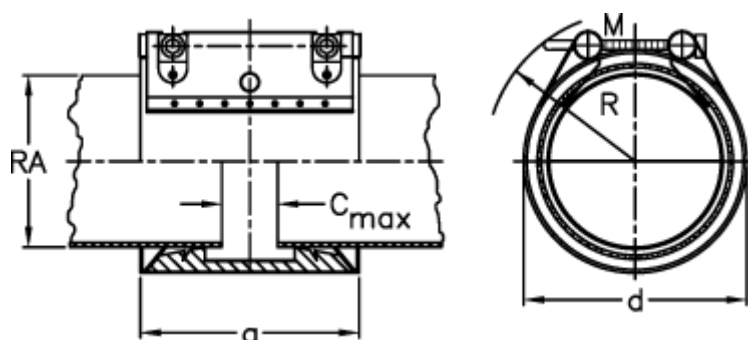

a	= 98.0
C max with insertion band	= 25
d	= 130
M (screw)	= M10
Nominal pressure (bar)	= 16
R	= 150
RA	= 110.0
RA min-RA max plastic	= 109,0-111,0

Weight a piece = 1.8